

EFORT

埃夫特智能装备股份有限公司
EFORT Intelligent Equipment Co., Ltd.

比例 1:1
Scale 1:1

页码 1/2
Page 1/2

运动范围图
Robot workspace

修订记录
revision record

ER12H-1600

End flange mounting size

末端法兰安装尺寸

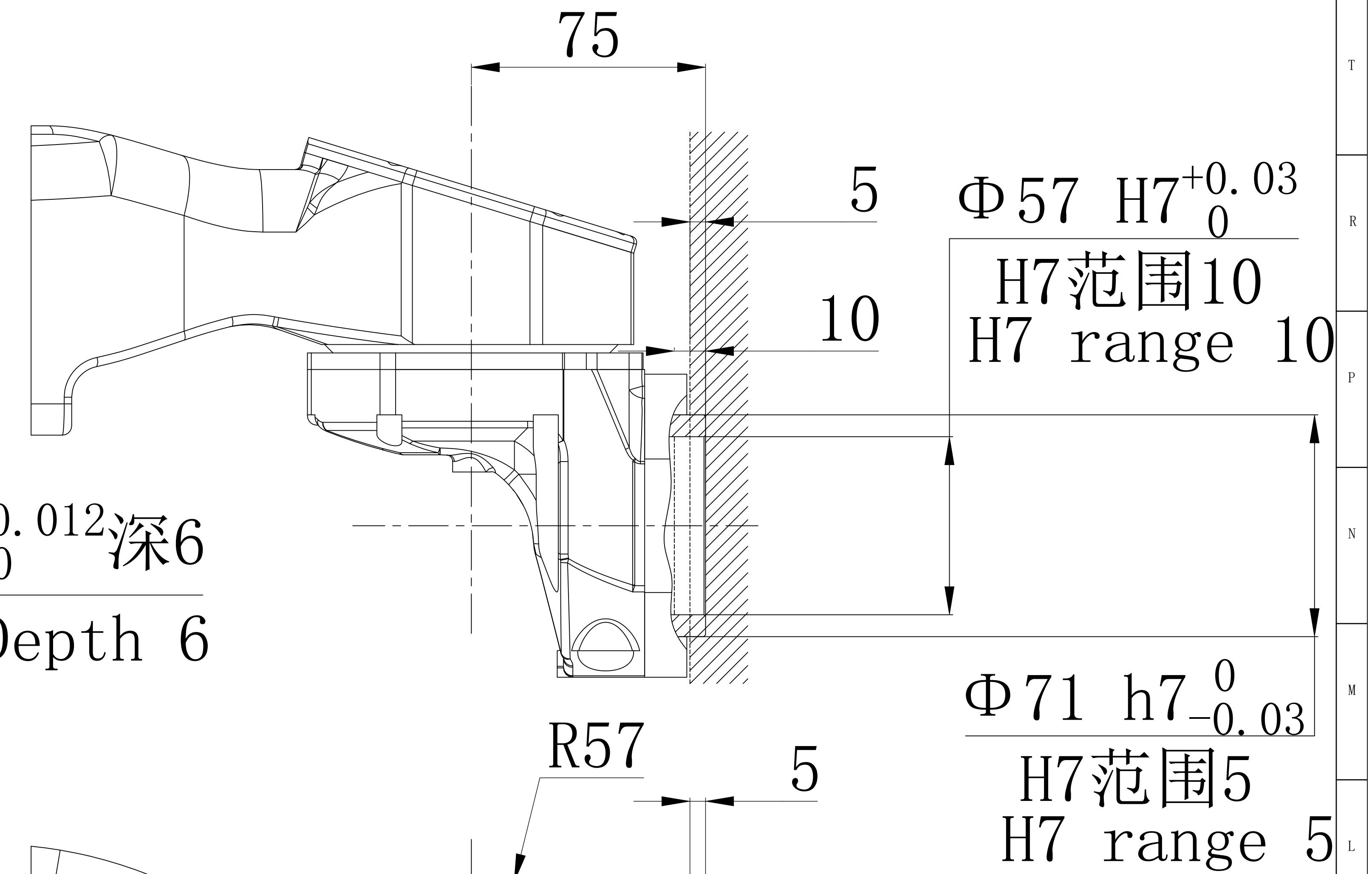
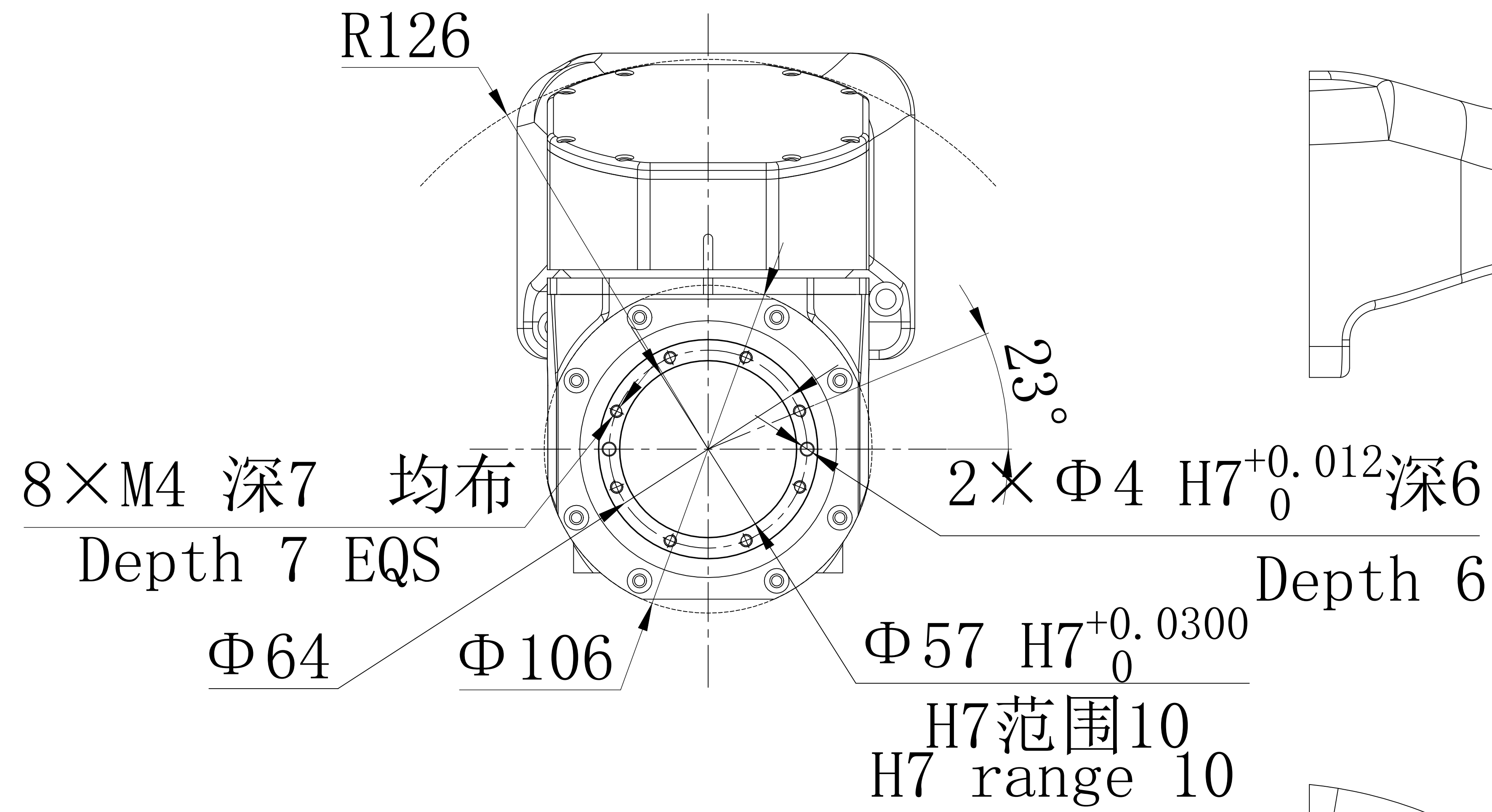

$4 \times \Phi 32$ 深2
 Depth 2

$4 \times \Phi 18$ 通
 Throughout

$2 \times \Phi 12 H7^{+0.0180}$
 $H7$ 范围10
 $H7$ range 10

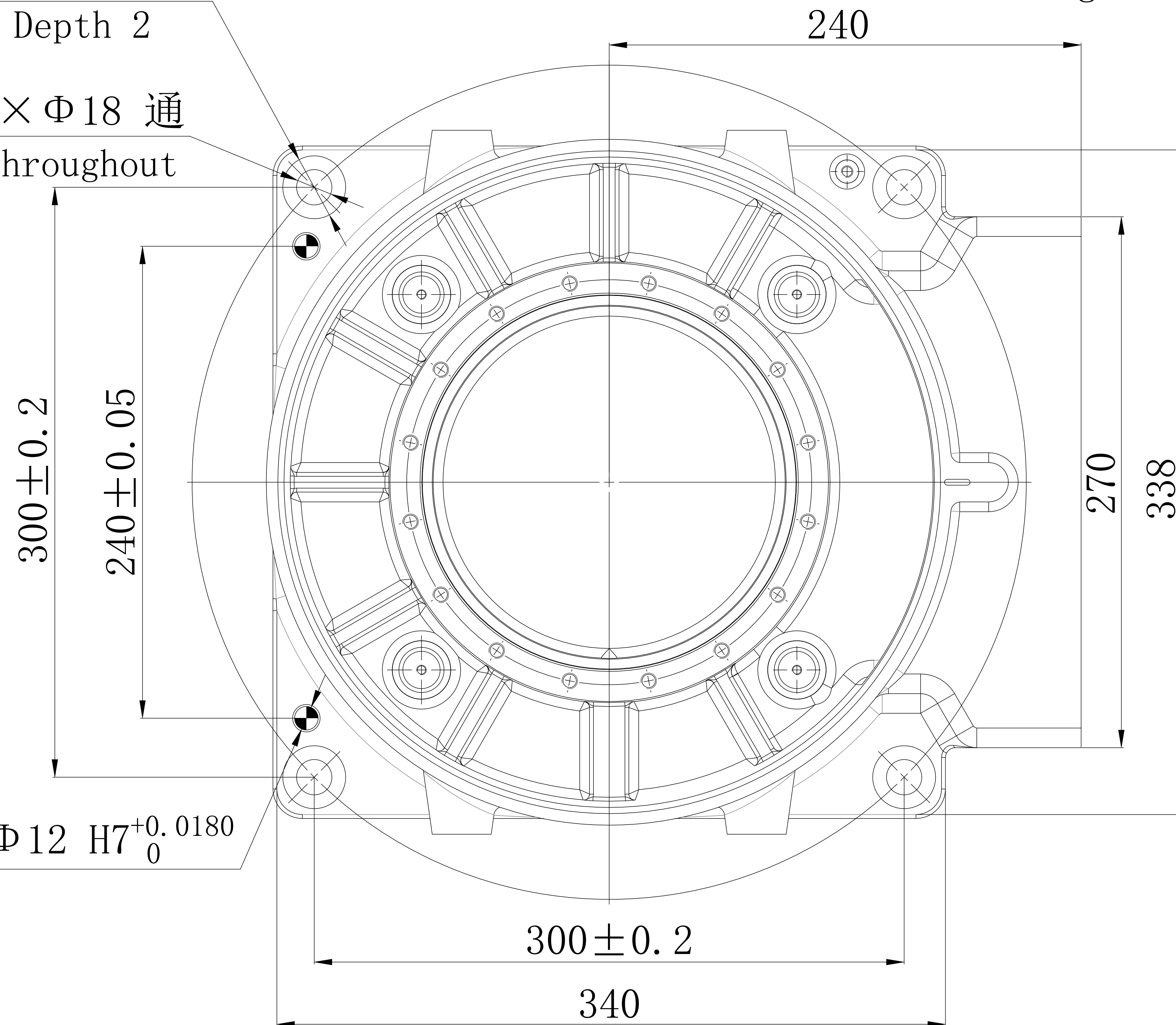

Base mounting size

底座安装尺寸

EFORT

埃夫特智能装备股份有限公司
 EFORT Intelligent Equipment Co., Ltd.

比例 1:1
 Scale 1:1
 页码 2/2
 Page 2/2

主要安装尺寸图
 Main dimensions

修订记录
 revision record

ER12H-1600